

**Axer Five**

The Advanced Laparoscopic Instrument



VSC Jaw Insert



**axer<sup>™</sup>** five

**CE**  
1639



**ISO**  
13485

Shalya offers an extensive selection of Reusable Laparoscopic instruments.

- Easy to Disassemble Design for Effective Cleaning and Sterilization.(Autoclavable).
- Cutting of tissue by blade (Blade can be replace)
- Design & Manufacturing as per international standards/norms.
- The unique Ergonomic Light Weight Design with Multiple Handgrip options.
- High Quality, High Reliability & Best Performance gives confidence to user.
- Can be suitable for most complicated Minimally Invasive Surgeries (MIS).
- Variety of Multiple Insert Options for various Surgical Applications.
- Automatic activation at closer of complete handle
- Spring Technology creates Unsurpassed Precision, Performance and Reliability.
- Compliance of Bio-compatibility & Electrical Test as per IEC 60601-1 & IEC 60601-2-2.
- Quick Lock & Easy to Assemble system.
- Autoclavable Instrument.
- World Wide Service Support.
- **360°** Jaw Insert Rotation with the rotor.



• Various hand-grip options for easy to use.

for Laparoscopy



VSC Jaw Insert



**R511-32**  
32cm

**R511-36**  
36cm

**R511-42**  
42cm

**R511-56**  
56cm

**E449**

Blade, 5mm Insert  
Pack of 10 Blade



**E448**

Blade Replacement  
& Jaw Cleaning Tool



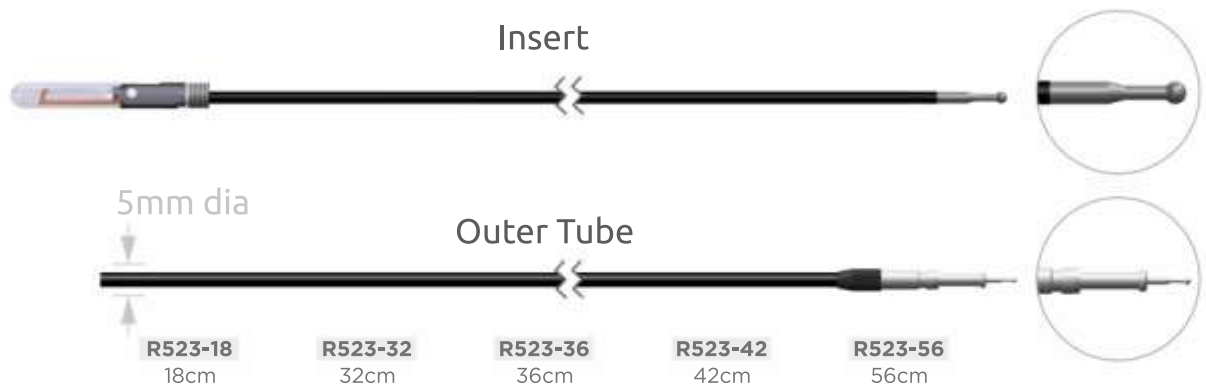

- axer five cable  
**R289**  
handswitching Cable  
Length - 3 Mtr, Material - Silicon

- axer five handle  
**R501**  
Vessel Sealing with Cutting Handle, 5mm

### Shalya Sigma+v



### Shalya Vista



**Recommended ESU**



**XcelLance Medical Technologies Pvt. Ltd.**

Shalya Avenue, W-239, Rabale MIDC, Navi Mumbai - 400 701. INDIA. ☎: +91-22-7114 2400.

**Axer Flex**

## The Multifunction Laparoscopic Instrument



Fenestrated Grasper  
Insert



Maryland Grasper  
Insert



Straight Sealer  
Insert



# axer<sup>™</sup>flex B

## Reduce cost and waste while optimizing surgical outcomes



Shalya offers an extensive selection of Reusable Laparoscopic instruments.

- Insert changeable & Easy to Assemble system.
- Design & Manufacturing as per international standards/norms.
- The unique Ergonomic Light Weight Design with Multiple Handgrip options.
- High Quality, High Reliability & Best Performance gives confidence to user.
- Can be suitable for most complicated Minimally Invasive Surgeries (MIS).
- Variety of Multiple Insert Options for various Surgical Applications.
- Spring Action & without Spring Action variants available.
- Compliance of Bio-compatibility & Electrical Test as per IEC 60601-1 & IEC 60601-2-2.
- Easy to Disassemble Design for Effective Cleaning and Sterilization (Autoclavable).
- Unique & Safe Ratchet Locking & Unlocking Mechanism with option of permanent detachment.
- World Wide Service Support.
- **360°** Jaw Insert Rotation with the rotor.

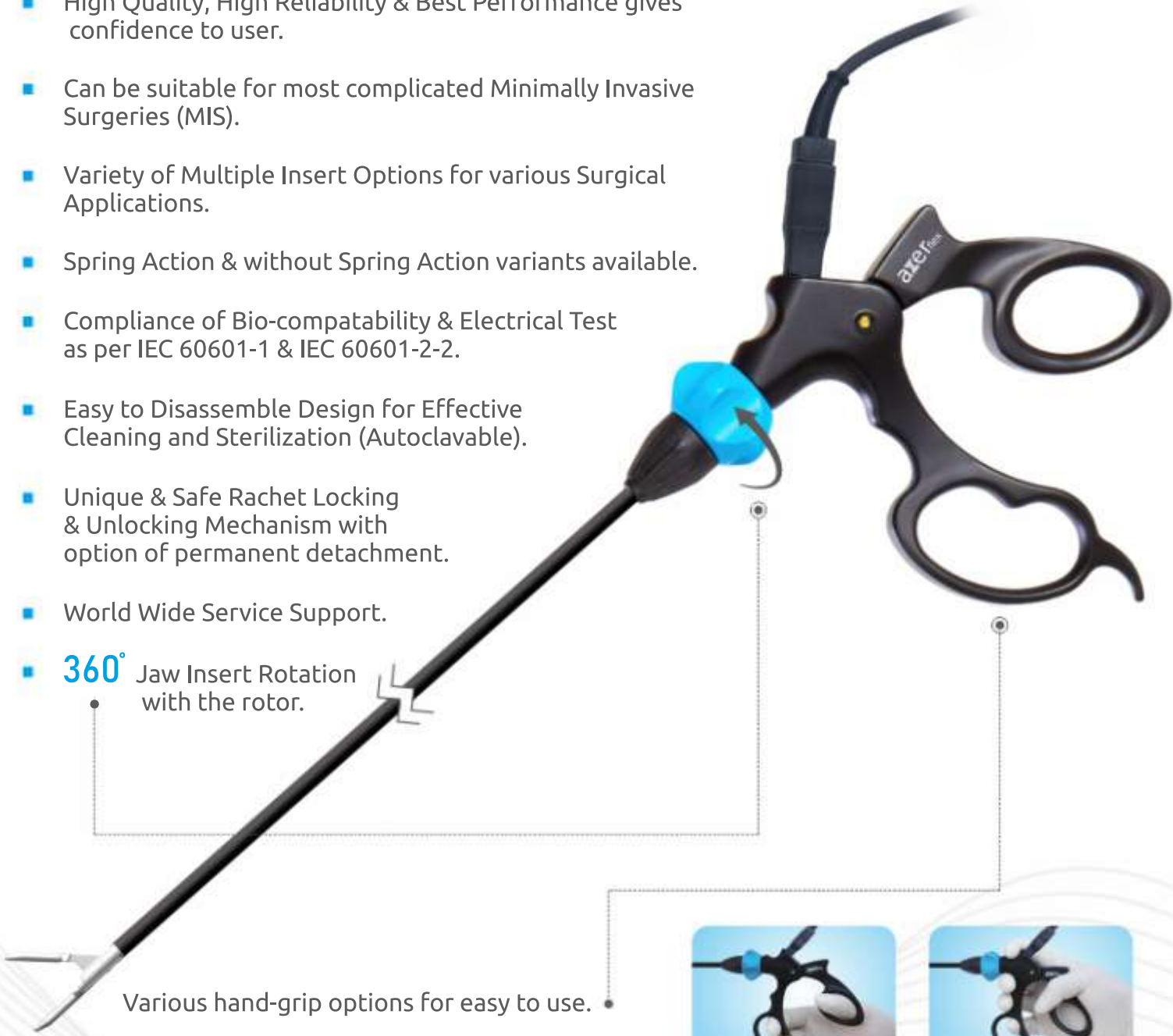

Various hand-grip options for easy to use.





Clinical Effects



RFaST



Bipolar



Sealing



Round Maryland Insert

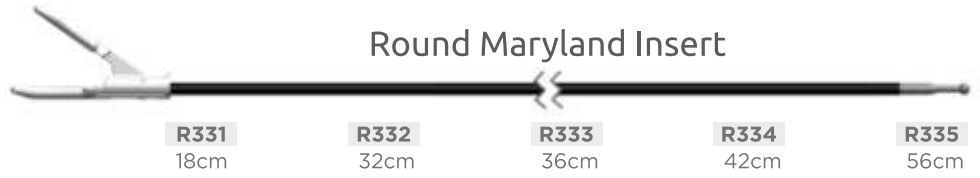

Triangular Maryland Insert

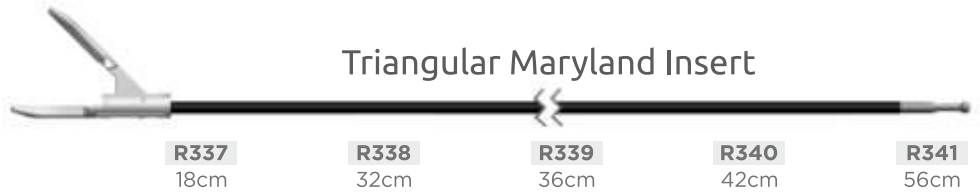

Fenestrated Grasper Insert

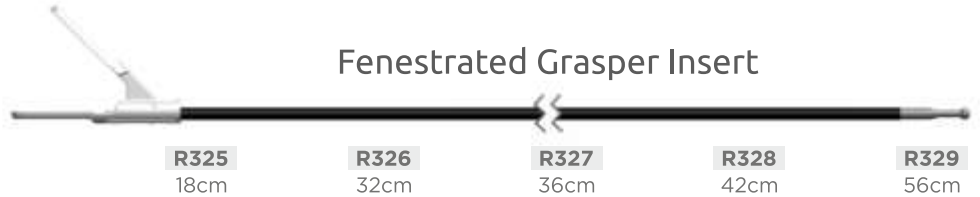

Maryland Grasper Insert

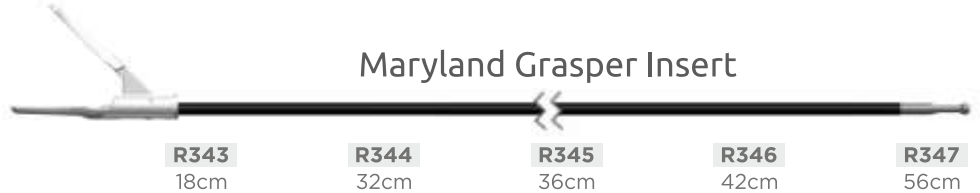

Straight Sealer Insert

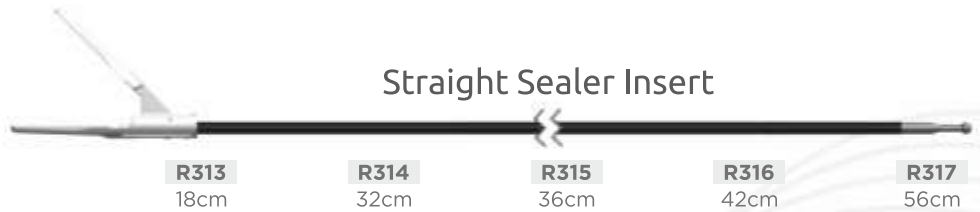

Maryland Sealer Insert

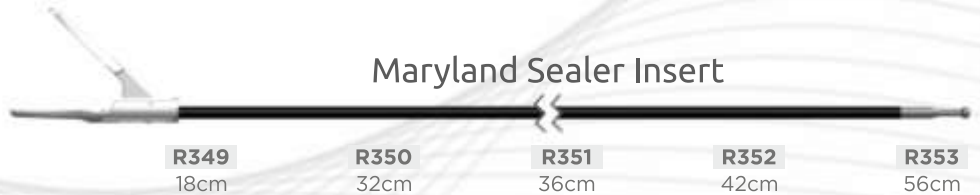

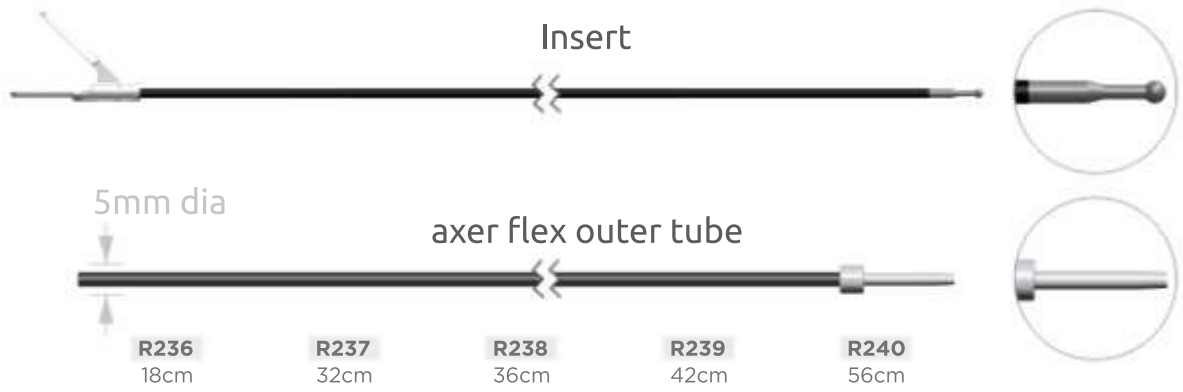

- axer flex handle BR  
**R210**  
Bipolar Laparoscopic Handle with Ratchet  
Weight - 145 gm



- axer flex handle B  
**R201** without spring action | **R202** with spring action  
Bipolar Laparoscopic Handle without Ratchet  
Weight - 140 gm

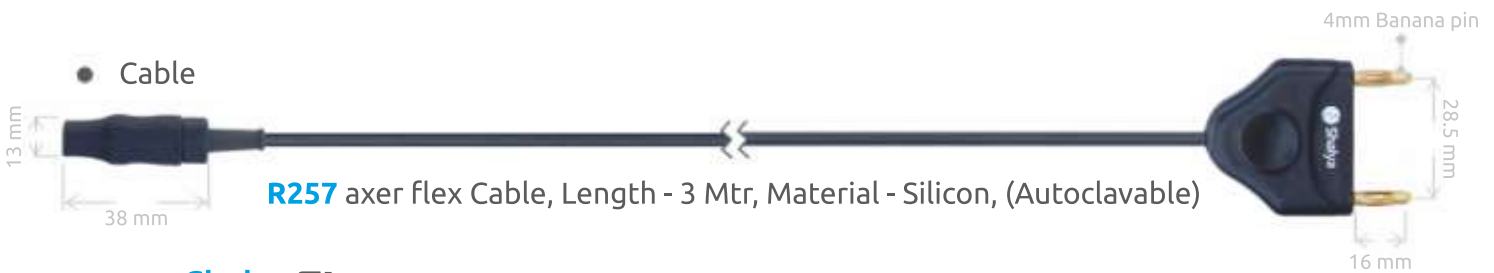

- Cable  
**R257** axer flex Cable, Length - 3 Mtr, Material - Silicon, (Autoclavable)

**Shalya Sigma+v**

**Shalya Vista**



**Recommended ESU**



**XcelLance Medical Technologies Pvt. Ltd.**

Shalya Avenue, W-239, Rabale MIDC, Navi Mumbai - 400 701. INDIA. ☎: +91-22-7114 2400.

**Axer Max**

The Advanced Laparoscopic Instrument



Fenestrated Grasper  
Insert



Maryland Grasper  
Insert



Straight Sealer  
Insert

**axer**<sup>™</sup>max A



Shalya offers an extensive selection of Reusable Laparoscopic instruments.

- Easy to Disassemble Design for Effective Cleaning and Sterilization.(Autoclavable).
- Design & Manufacturing as per international standards/norms.
- The unique Ergonomic Light Weight Design with Multiple Handgrip options.
- High Quality, High Reliability & Best Performance gives confidence to user.
- Can be suitable for most complicated Minimally Invasive Surgeries (MIS).
- Variety of Multiple Insert Options for various Surgical Applications.
- Yellow button for cut & Blue for coagulation.
- Spring Technology creates Unsurpassed Precision, Performance and Reliability.
- Compliance of Bio-compatibility & Electrical Test as per IEC 60601-1 & IEC 60601-2-2.
- Quick Lock & Easy to Assemble system.
- Autoclavable Instrument.
- World Wide Service Support.
- **360°** Jaw Insert Rotation with the rotor.



• Various hand-grip options for easy to use.



Clinical Effects



RFaST



Round Maryland Insert



Triangular Maryland Insert



Fenestrated Grasper Insert



Bipolar



Maryland Grasper Insert



Straight Sealer Insert



Sealing



Maryland Sealer Insert

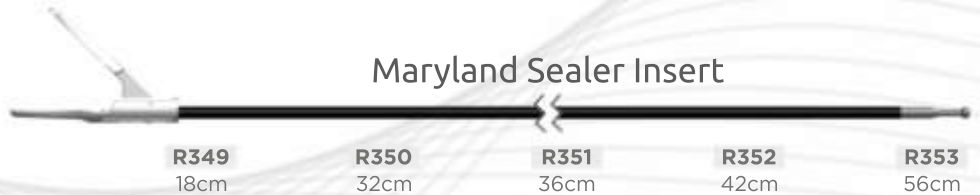

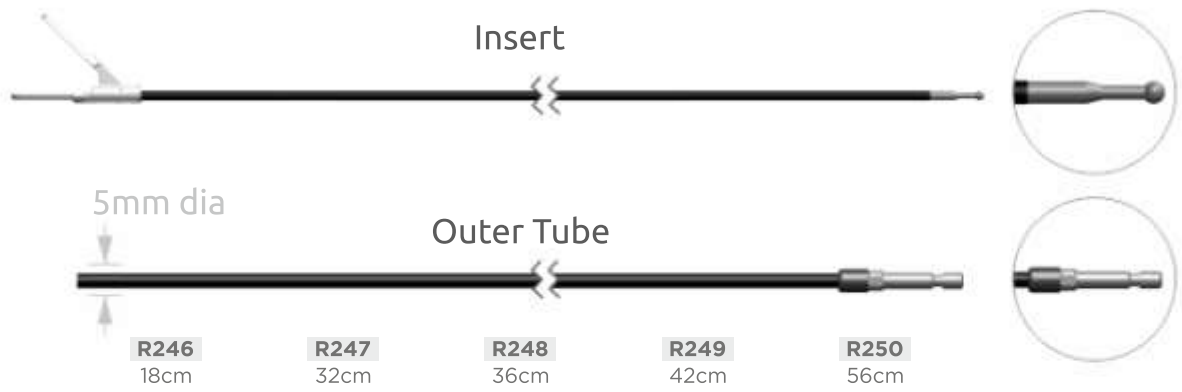

- axer max A cable  
**R285**  
DHA-Bipolar handswitching Cable  
Length - 3 Mtr, Material - Silicon

- axer max A handle  
**R228**  
Advanced Bipolar Laparoscopic Handle  
Weight - 140 gm

### Shalya Sigma+v



### Shalya Vista



**Recommended ESU**



**XcelLance Medical Technologies Pvt. Ltd.**

Shalya Avenue, W-239, Rabale MIDC, Navi Mumbai - 400 701. INDIA. ☎: +91-22-7114 2400.